

PRODUCT BROCHURE

SMARTEMP[®]
IN COMFORT



Inclined Floor Swirl Diffuser

ISF-AD

Optional Features:
Constant throw height adjustable airflow rate
Electrical VAV operation

DESCRIPTION

The SMARTEMP® Inclined Floor Swirl Diffuser, type ISF-AD (figure 1), is a high induction, low air velocity floor swirl diffuser for optimising occupant thermal comfort in “task-ambient” underfloor air distribution applications. The patent pending design provides users with enhanced personal control of their local thermal environment, minimises the vertical temperature gradient for seated occupants regardless of the airflow rate setting, and maximises face level indoor air quality.

User adjustment of both diffuser airflow rate and airflow direction allows users to customise their local temperature and air motion to achieve enhanced thermal comfort personalisation (figure 2). The inclined discharge pattern of the diffuser maintains largely constant throw to head height of seated occupants regardless of the airflow damper setting, preventing throw from being reduced when the diffuser airflow damper is throttled.

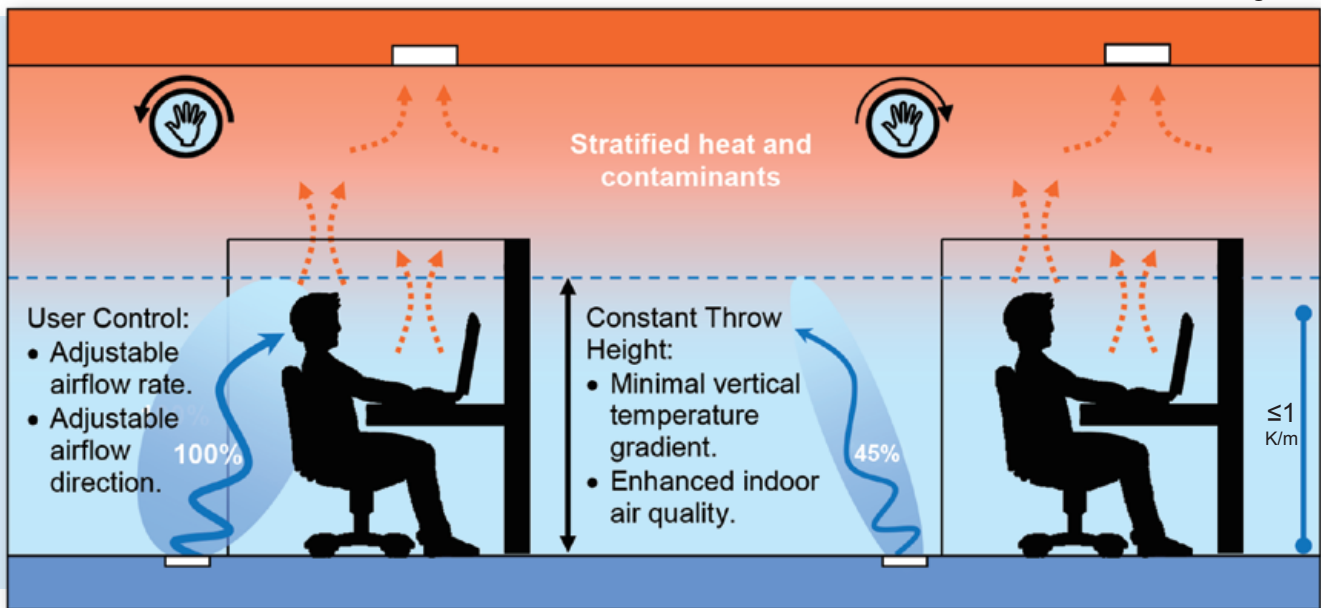

Figure 1

This unique feature achieves three advantages:

- 1. Enhanced thermal comfort** is maintained by averting the sensation of “cold feet / warm head” at reduced airflow rate settings.
- 2. Superior indoor air quality** is maintained by preventing encroachment of high level stratified contaminants into the breathing zone at reduced airflow rate settings.
- 3. Effective heat removal** and enhanced indoor air quality are maintained at increased airflow rate settings (ie no over-throw agitating the high level stratified layer of heat and contaminants to mix into the occupancy micro-climate).





Damper stops offer a choice of fixed airflow rates and adjustable airflow rate ranges, including ones of marginal adjustability (table 1). User-adjustable airflow rate throttling may be marginal or eliminated entirely, if desired, due to the availability of discharge direction adjustment as an alternative to achieve thermal comfort personalisation by the user. This enhances indoor air quality by maximising airflow rates.

An aesthetically appealing symmetrical face design, in textured plastic or surface treated aluminium, compliments contemporary décor and is available in a multitude of custom colours. The diffuser is suitable for use in pressurised access floor air distribution systems, and may optionally be ducted. A rapid mount assembly feature provides quick and easy installation or relocation without the need for tools or for access from below.

The ISF-AD floor swirl diffuser is available in any one of four **CONFIGURATIONS**, in each of which simple hand rotation of the diffuser face tailors “task” conditioning to optimise the user's individual thermal comfort

- **Standard: “I = Inclined”** (figure 3)

User-adjustable:

- discharge direction (by rotation);
- airflow rate (3 adjustable; 4 fixed).

Typical applications:

- offices;
- work stations.

- **Option “E = Electrical VAV”** (figure 4)

User-adjustable:

- discharge direction (by rotation);
- air pattern (inclined-vertical).

Typical applications:

- board rooms;
- meeting rooms.

- **Option “V = Vertical”** (figure 5)

User-adjustable:

- airflow rate (3 adjustable; 4 fixed).

Typical applications:

- foyers;
- transient spaces.

- **Option “IV = Inclined-Vertical”** (figure 6)

User-adjustable:

- discharge direction (by rotation);
- airflow rate (4 adjustable);
- air pattern (inclined-vertical).

Typical applications:

- reconfigurable spaces.

Figure 3

OFFICES & WORK STATIONS

I = Inclined

Difuser face rotation directs the gentle, inclined air stream towards / away from the user. Airflow rates: 4 fixed & 3 user-adjustable. For the latter, counter-clockwise / clockwise face rotation increases / decreases the airflow rate, respectively. Throw projects to head height of seated occupants.

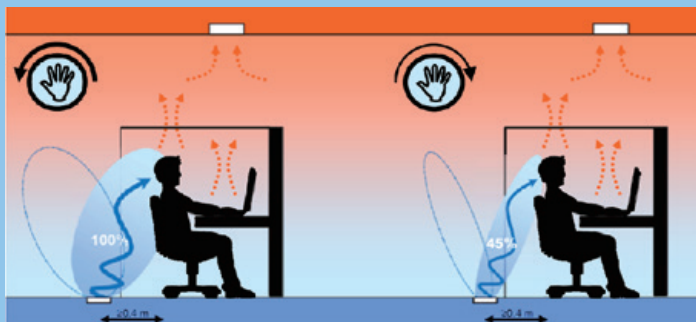

Figure 4

BOARD ROOMS & MEETING ROOMS

E = Electrical VAV

Electrical VAV difuser airflow rate adjustment. Counter-clockwise difuser face rotation forms a gentle inclined air stream to head height of seated occupants. Further rotation directs the air stream towards / away from the user. Clockwise rotation forms a barely perceptible vertical air stream trimmed to a reduced VAV airflow rate range.

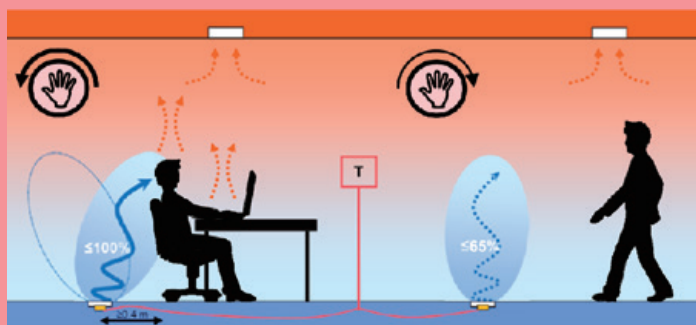

Figure 5

FOYERS & TRANSIENT SPACES

V = Vertical

The air stream is vertically directed and barely perceptible. Airflow rates: 4 fixed & 3 user-adjustable. For the latter, counter-clockwise / clockwise face rotation increases / decreases the airflow rate, respectively. Throw height is directly proportional to airflow rate.

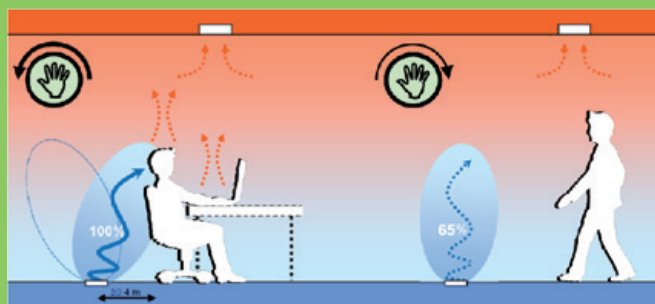

Figure 6

RECONFIGURABLE SPACES









IV = Inclined-Vertical

Airflow rates: 4 user-adjustable. Counter-clockwise diffuser face rotation forms a gentle, inclined air stream to head height of seated occupants. Further rotation directs the air stream towards / away from the user. Clockwise diffuser face rotation forms a barely perceptible vertical air stream of reduced airflow rate.



AIRFLOW RATE FACTORS

Table 1

Damper	Symbol	Min □	Low ▢	Med ▣	High ▤	Max ▥
Fixed	I  Inclined a b c d	-	0.45 a	0.75 b	0.85 c	1.0 d
User Adjustable	I  Inclined e	-	0.45 ... e			1.0
	I  Inclined f g	-	0.45 ... f	0.75	0.85... g	1.0
	E  Electrical VAV	0.1 ... 0.45 Electric actuator @ 10 V	0.4 ... 0.75 Electric actuator @ 7 V	0.5 ... 0.85 Electric actuator @ 5 V	0.65 ... 1.0 Electric actuator @ ≤ 2 V	
Fixed	V  Vertical a b c d	0.1 a	0.4 b	0.5 c	0.65 d	-
User Adjustable	V  Vertical e	0.1 ... e	0.65			-
	V  Vertical f g	0.1 ... f	0.4	0.5 ... g	0.65	-
	IV  Inclined Vertical a b c d	0.1 ... 0.45 a	0.4 ... 0.75 b	0.5 ... 0.85 c	0.65 ... 1.0 d	

DIFFUSER PLACEMENT

Standard features include:

- Configuration “I = Inclined” (figure 3): Gentle inclined air pattern. User adjustable discharge direction. Airflow rate optionally user-adjustable.
 - 1 Integrated volume flow rate damper, which may be set during installation to:
 - a. one of four fixed airflow rates (low, med, high, max), or
 - b. one of three adjustable airflow rates (low-med, high-max, low-max), each user-adjustable by hand rotation of the diffuser face.
 - 2 Largely constant throw to head height of seated occupants, regardless of the volume flow rate damper setting.
 - 3 Visual indicator of the inclined air pattern and volume flow rate damper setting.
 - 4 Shallow saw-tooth profile dust receptacle basket, extending just 97 mm (3.82 in) down from finished floor level, suitable for low floor plenum heights and for installation above services within the floor plenum.
 - 5 Low design supply air temperature: down to 17°C (63°F).
 - 6 Quiet operation: ≤ 36 dB(A) sound power level @ 25 Pa (0.100 in wg), depending on damper setting.
 - 7 Mounting ring includes a quick mount double lipped rubber wedge collar that wedges into the floor penetration from above for rapid installation (no access from below required).
 - 8 Wide mounting ring lip clamps carpet to floor.
 - 9 Dust receptacle basket and damper made of black ABS, V0 fire rated.
 - 10 Swirl discharge element and mounting ring made of:
 - a. high-impact polycarbonate, V0 fire rated (standard colour grey, custom colours available on request), or
 - b. aluminium (optionally powder coated).
 - 11 High maximum airflow rate: 54 L/s (194 m³/h or 114 cfm) @ 25 Pa (0.100 in wg), depending on damper setting.
- Optional Configuration “E = Electrical VAV” (figure 4): 24 V, 2-10 V proportional electric VAV diffuser airflow rate modulation. User-adjustable discharge direction. Combined user-adjustable air pattern and airflow rate trimming.
 - Integrated volume flow rate damper, electrically operated by a Belimo 24 V, 2-10 V proportional actuator.
 - Largely constant throw to head height of seated occupants when discharge pattern is inclined, regardless of the electrically operated VAV damper setting.
 - Includes optional air pattern damper for user-adjustable air pattern adjustment (inclined-vertical) by rotation of the diffuser face.
 - Visual indicator of the user-adjustable air pattern setting (inclined/vertical).
Saw-tooth profile dust receptacle basket, actuator, mechanism and cable, extending 170 mm (6.69 in) down from finished floor level.
 - Includes items 5 to 11 above.

- Optional Configuration “V = Vertical” (figure 5):
Almost imperceptible vertically directed air pattern.
Airflow rate optionally user-adjustable.
 - Integrated volume flow rate damper, which may be set during installation to:
 - a. one of four fixed airflow rates (min, low, med, high), or
 - b. one of three adjustable airflow rates (min-low, med-high, min-high), each user-adjustable by hand rotation of the diffuser face.
 - Includes optional air pattern damper to direct the air pattern vertically.
 - Visual indicator of the vertical air pattern and volume flow rate damper setting.
 - Includes items 4 to 10 above.
 - Airflow rate: ≤ 35 L/s (≤ 126 m³/h or ≤ 74 cfm) @ 25 Pa (0.100 in wg), depending on damper setting.

- Optional Configuration “IV” (figures 6): User adjustable discharge direction. Combined user-adjustable air pattern and airflow rate.
 - Integrated volume flow rate damper, which may be set during installation to one of four adjustable airflow rates (min-low, low-med, med-high, high-max).
 - Largely constant throw to head height of seated occupants when discharge pattern is inclined, regardless of the volume flow rate damper setting.
 - Includes optional air pattern damper for combined user-adjustable air pattern and airflow rate by rotation of the diffuser face.
 - Visual indicator of the user adjustable air pattern setting (inclined / vertical).
 - Includes items 4 to 11 above.

TECHNICAL DATA

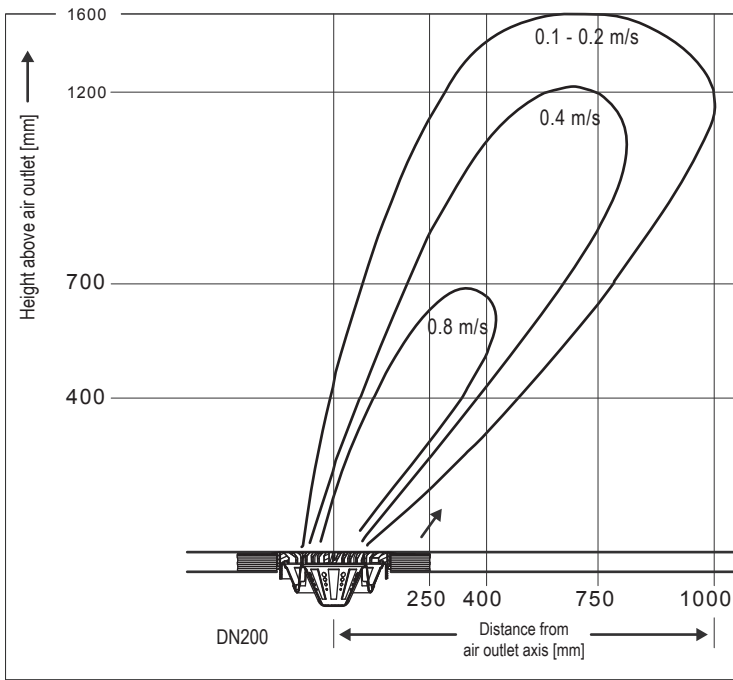

Figure 7 : Air velocities @ 42 L/S
 $\Delta T_{\text{SUPPLY-ROOM}} = -5 \text{ K (1.2 m height)}$



Figure 8 : Inclined discharge - max 100%

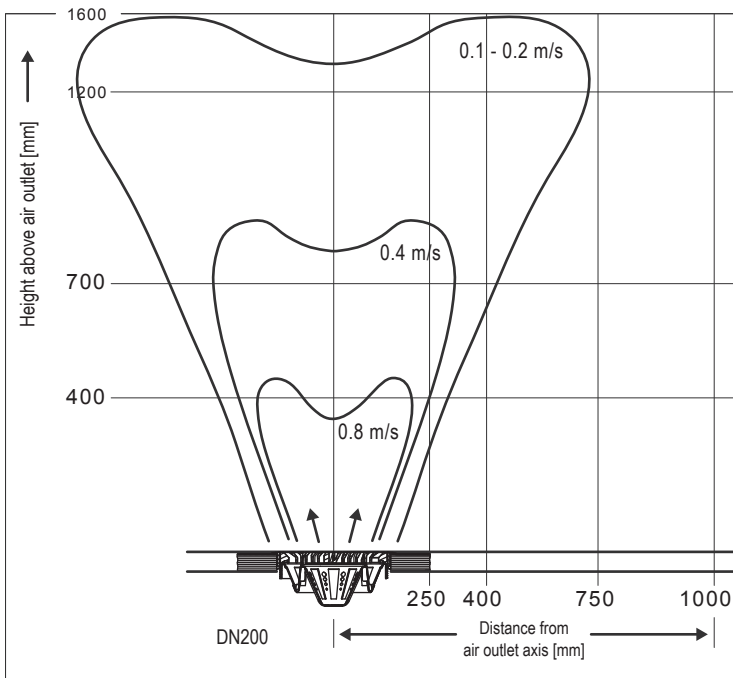

Figure 9 : Air velocities @ 42 L/S
 $\Delta T_{\text{SUPPLY-ROOM}} = -5 \text{ K (1.2 m height)}$



Figure 10 : Vertical discharge - max 65%

Performance

Quick selection guide. Refer to the online selection tool for detailed selections.

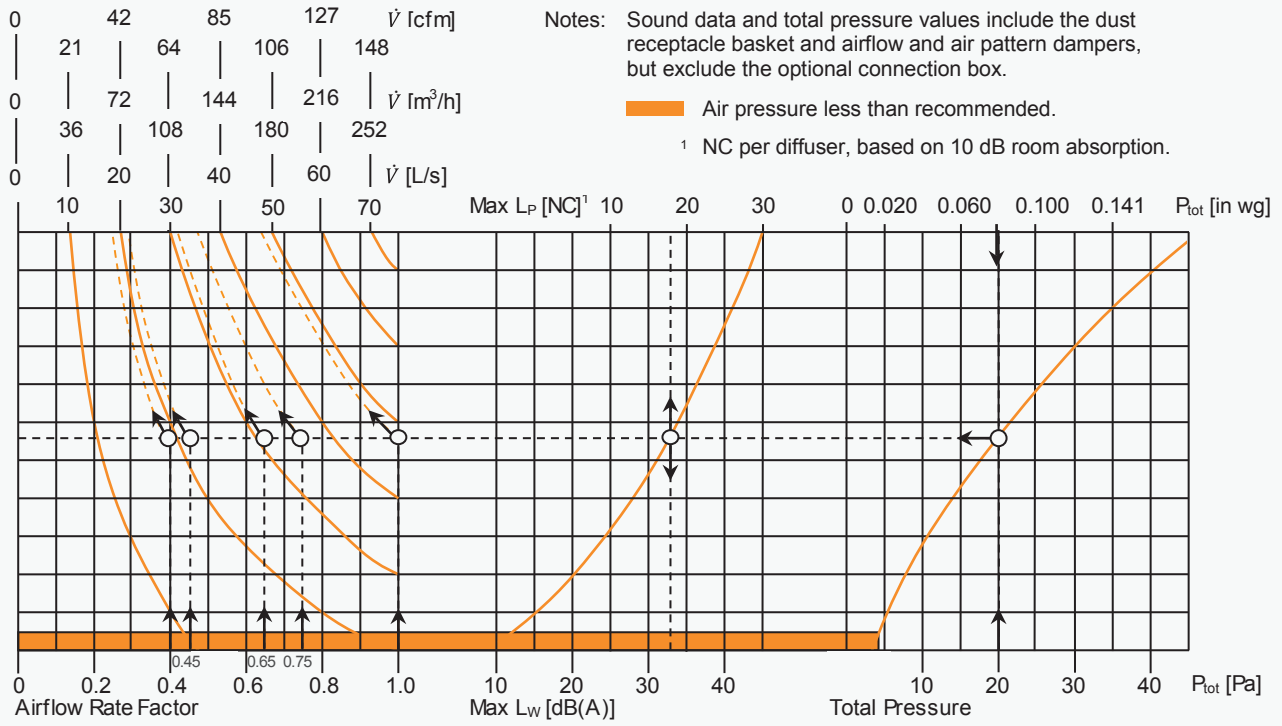

Performance Parameters

Diffuser Model	ISF-AD-P	ISF-AD-A
Maximum airflow rate at 25Pa	54 L/s (194 m³/h or 114 cfm)	
Recommended supply air temperature range	17 °C (63 °F) to 35 °C (95 °F)	
Minimum outlet centre-line spacing	0.6 m	
Minimum distance to seat *	0.4 m	
Materials:	ABS, V0 fire rated	
Dust receptacle basket & dampers		
Swirl discharge element & mounting ring	PC, V0 fire rated	Al
Maximum load	500 kg	2100 kg

*For outlet mounted directly beneath a seat, please refer to brochure:
 "Auditorium Swirl Floor Adjustable Diffuser, type ASF-AD for underseat installation"

Dimensions

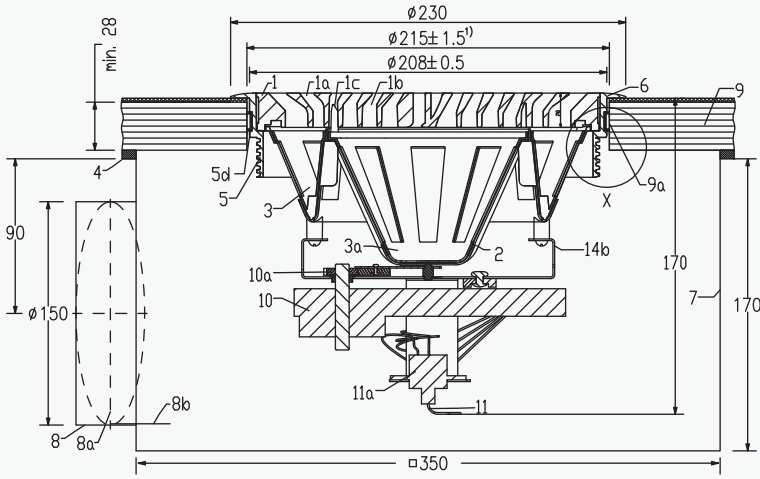

ISF-AD with RR mounting ring, optional electric VAV actuator, and optional connection box type CK

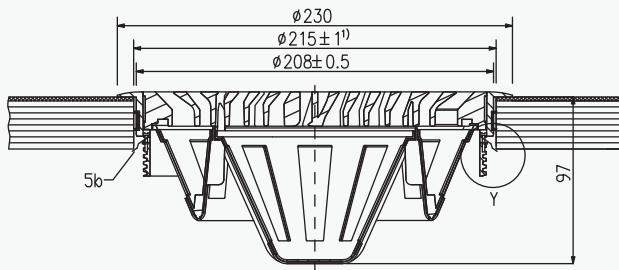

ISF-AD with RC mounting ring

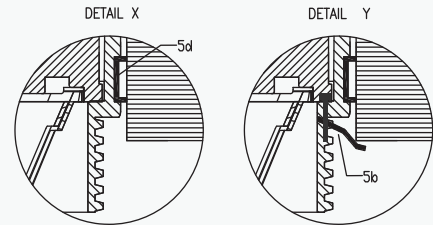

Detail X: RR mounting ring
Rubber wedge collar only

Detail Y: RC mounting ring
Rubber wedge collar and claw fastener

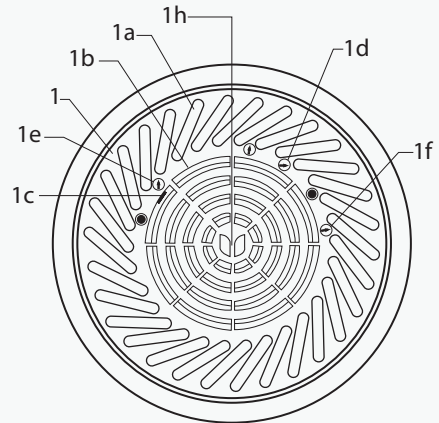

Notes: 1) Cut-out dimension / all dimensions in mm

Key

1	Swirl discharge element	1a	Swirl discharge slot
1b	Inclined discharge slot	1c	Air pattern & flow rate indicator
1d	Configuration IV or E	1e	Configuration I at max airflow
1f	Configuration V at max airflow	1h	Pointer for inclined discharge direction
2	Dust receptacle basket	3	Volume flow rate damper
3a	Air pattern damper (options E, V, IV)	4	Sealant (on site, by others)
5	Mounting ring	5b	Claw fastener
5d	Rubber wedge collar	6	Trim lip
7	Connection box	8	Connection spigot
8a	Airflow balancing damper (optional)	8b	Lever arm
9	Access floor tile (by others)	9a	Floor penetration
10	Electric VAV actuator (option E)	10a	VAV actuator / mechanism (option E)
11	Electric cable (option E)	11a	360° Rotator (option E)

Figure 11: Dimensions

Example

Conditioned air with a min temperature of 16° C (63° F) is supplied to a floor plenum at 20 Pa (0.080 in wg). The heat pick-up in the floor plenum is 1K. Select ISF-AD floor swirl diffusers for the following two applications:

- i. Offices and workstations, with INCLINED airflow pattern and user-adjustable airflow rate from 100% down to 45%.
- ii. Meeting rooms, with ELECTRICAL VAV diffusers, turning down from 100% to 40%.

For the above, determine the maximum diffuser sound power level (LW), as well as the calculated diffuser regenerated sound pressure level per diffuser (LP) in the space based on 10 dB room absorption.

Assuming ceiling return air grilles @ 2.7 m (8.9ft) height, what is the maximum sensible load that can be removed from the space by each diffuser, and what are the typical air temperatures:

- a) at each diffuser;
- b) at 1.2 m (3.9 ft) height (i.e. face level); and
- c) at each return air grille.

Solution: For 20 Pa (0.080 in wg):

- i. From Table 1, select damper setting I-e.

This provides INCLINED discharge with a maximum airflow rate factor of 1.0 that can be turned down by the user to 0.45 minimum, equating to a user-adjustable airflow rate range of 48 L/s (173 m³/h or 102 cfm) to 22 L/s (79 m³/h or 47 cfm) in the nomogram above.

- ii. From Table 1, select damper setting E, which provides ELECTRICAL VAV damper operation.

Maximum VAV airflow is achieved at ≤ 2 V control signal, for which the user can adjust the airflow rate factor from 1.0 to 0.65, equating to an upper user-adjustable airflow rate range of 48 L/s (173 m³/h or 102 cfm) with inclined discharge to 36 L/s (130 m³/h or 76 cfm) with vertical discharge.

Turn down to 40% VAV airflow is achieved at 7 V control signal, for which the user can adjust the airflow rate factor from 0.75 to 0.4, equating to a lower user-adjustable airflow rate of range 36 L/s (130 m³/h or 76 cfm) with inclined discharge to 17 L/s (61 m³/h or 36 cfm) with vertical discharge.

The maximum diffuser sound power level (LW) is 33 dB(A), which equates to a maximum calculated regenerated sound pressure level (LP) in the space of NC 18 per diffuser based on 10 dB room absorption.



Figure 12

ORDER DETAILS

ISF-AD- _DN200-B _D _R _RAL _C _

CONNECTION:

- O* No connection
- K Connection box

RAL COLOUR:

- ST* Standard grey/alu finish
- _____ 4 digit RAL colour code

MOUNTING RING:

- O No mounting ring
- R* with rubber wedge collar
- C⁴ with rubber wedge collar and claw fasteners

DAMPERS²:

- O No damper
- E Electric Actuator
- IVd^{*.5} Inclined-Vertical – high-max³

BASKET¹:

- O No Basket
- W* Dust receptacle basket

MATERIAL:

- A Aluminium
- P* Polycarbonate

MODEL:

- Inclined Swirl Floor - Adjustable Direction

Notes:

* Standard, if no type code entered.

¹ Only with Mounting Ring.

² Only with Basket.

³ Other damper settings to be selected on site.

⁴ Only with Aluminium Mounting Ring.

⁵ Damper fixed; swirl discharge element, basket and mounting ring unassembled.

Products supplied may differ slightly from those described in this technical brochure due to on-going product development.

Furnish and install high induction SMARTEMP® Inclined Floor Swirl Diffuser, type ISF-AD, of the type shown on the plans and air distribution schedules. The swirl discharge element and mounting ring shall be constructed of high impact polycarbonate or of cast aluminium, as specified, with all other components of ABS. The mounting ring shall include a broad trim lip to clamp carpeting to the floor. The swirl discharge element shall form the visible face of the diffuser and shall be round and removable. The swirl discharge element shall have a largely symmetrical slot pattern that produces an inclined swirl air stream of low velocity about an axis offset approximately 30° from the vertical. The inclined swirl air stream shall be user-rotatable about the diffuser vertical axis via hand rotation of the swirl discharge element. A volume flow rate damper shall regulate the airflow rate. The volume flow rate damper may optionally be engaged with the swirl discharge element to provide user adjustment of the volume flow rate via hand rotation of the swirl discharge element. The vertical throw of the discharged air stream shall remain substantially constant throughout the range of airflow rate adjustability. An optional air pattern damper shall allow the air pattern to be adjusted from inclined to vertical. The air pattern damper may optionally be engaged with the swirl discharge element to provide user adjustment of the air pattern from inclined to vertical via hand rotation of the swirl discharge element. Both dampers shall be housed in a dust receptacle basket and shall each offer the choice of user-adjustability without removing the swirl discharge element, and fixed positions alterable only after removing the swirl discharge element.

The volume flow rate damper shall include both user-adjustable damper positions with a selection of minimum and maximum damper stops, as well as a selection of fixed damper positions. The dust receptacle basket shall have a saw-tooth profile and shall extend 97 mm (3.82 in) from finished floor level to the basket underside to allow installation in shallow floor spaces or above services. An optional electric actuator and associated actuator mechanism may be fixed beneath the dust receptacle basket, extending the depth of the diffuser assembly to 170 mm (6.69 in) below finished floor level. The electric actuator mechanism shall engage with the volume flow rate damper to provide VAV regulation of the swirl air stream. An indicator, visible through a slot of the swirl discharge element, shall provide the user with visual determination of air pattern and airflow rate. Unless otherwise specified, the diffuser shall have a secure compression fit rubber clamp collar for quick installation from above – without tools – into floor panels without requiring floor panel removal. Unless otherwise specified, the polycarbonate discharge element and mounting ring finish shall be textured grey, whereas the aluminium discharge element and mounting ring finish shall be surface treated aluminium. All other components shall be black with the exception of visible indicators, colour coded assembly symbols and the optional electric actuator mechanism.



For additional information, please contact info@smartemp.com

We strive to continually improve SMARTEMP products. Brochures and marketing material are subject to change without notice, and may not reflect the most recent product variants. Please contact us or consult your SMARTEMP sales representative for current specifications or more detailed information. Not all products may be available in all geographic regions.

Applicable Patents and Trade Marks can be viewed at smartemp.com/patents

Not to be reproduced, wholly or in part, without the written permission of SMARTAIR DIFFUSION Pty. Ltd.

® SMARTEMP is a registered trade mark. © 2018.