

Aircell Polymer Floor Diffusers

WFOR / WFOV / WFOI

Introduction

The Waterloo Aircell WFO series floor diffusers offer the choice of horizontal or vertical air patterns with its flip over design, as well as a host of other unique & patented features.

The WFOV low pressure vertical supply disc offers vertical projection with a 50% increase in air volume capacity, compared with standard WFOR units.

The WFOI provides a high induction discharge pattern at between 30 and 45 degrees which provides dynamic mixing that results in efficient velocity equalisation within the occupied zone.

The WFO diffuser discs are 200mm Ø and have been designed to resist permanent deformation when subjected to point loads up to 500 kg.

The WFOV diffuser disc is suitable for point loads up to 300kg.

All materials used are fire retardant.

Product Description

WFOR Pressurised Floor Void - Tile installation suitable for fitting into standard floor tile thicknesses of up to 50mm, supplied with a locking collar which is screw fixed to the underside of the tile

WFOIT As above but with high induction disc

WFOVT As above but with low pressure vertical air pattern disc

WFORS Pressurised Void - Slab floor installation supplied with a steel adaptor collar which is cast into the floor slab. The diffuser can then be installed into the collar with concealed spring clips

WFORP Ducted installation with plenum

WFOVP As above but with low pressure vertical air pattern disc

WFOID Step Drilled Installation. The diffuser disc only is supplied, suitable for installation into pre-cut holes in floor tiles.

Features

- Unique 'flip-over design' (WFOR)
- Memory locating peg
- Easy fit locking collar
- Concealed fixing bracket for concrete / slab flooring
- Combined damper / dirt tray with incremental damper positioning
- Heavy duty glass reinforced polycarbonate construction
- Compact plenum with optional spigots to suit 100 or 125mm ducting

Finishes

WFO diffusers are available in a slate grey finish (RAL 7037 Mid Grey) as standard. Other colours can be specified subject to a minimum quantity.

Advantages

- Ability to change between horizontal and vertical settings instantly (WFOR)
- Commissioning settings are retained once set using the memory locating peg
- Reduced installation time with easy fit locking collar

WFOR Standard Disc Performance

Performance Graph

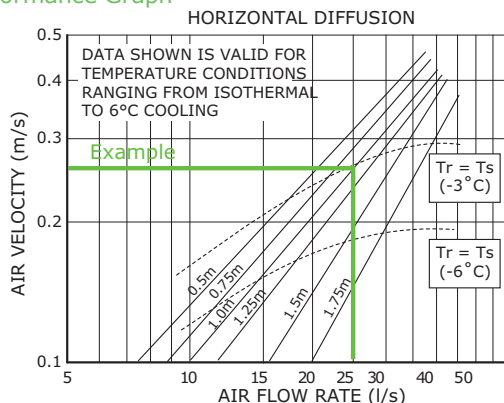

The dotted lines represent the approximate distances from the diffuser where the jet air temperature (Ts) is the same as the room air temperature (Tr).

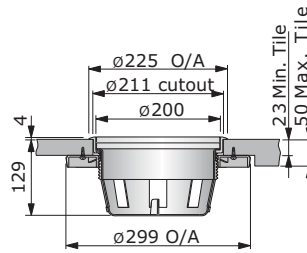

WFOR WFOVT WFOIT

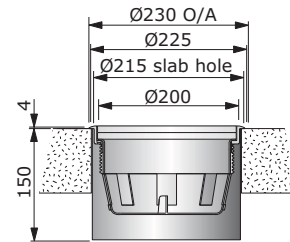

WFORS

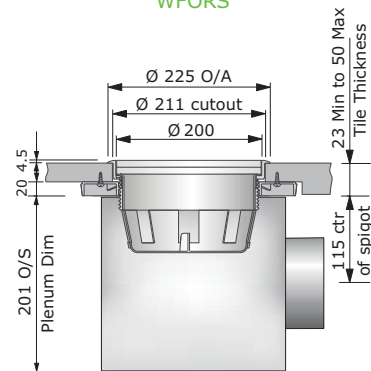

WFORP WFOVP

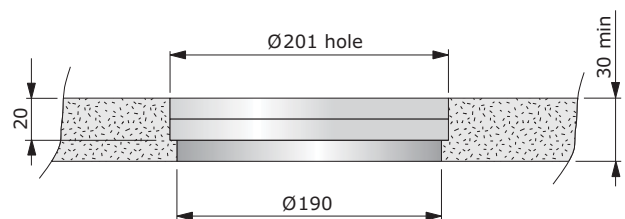
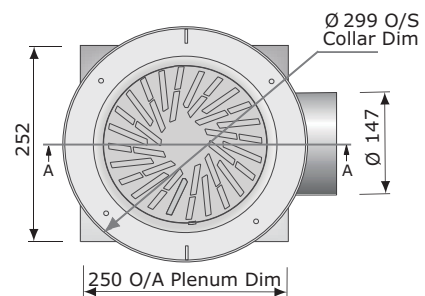

WFORD

Product Type Code	
I	Intermediate Type
R	Reversible Type
V	Vertical Type
D	Disk only
P	Plenum installation type
S	Slab installation type
T	Tile installation type

ORDER EXAMPLE

WFOR

Type _____

Aircell Polymer Floor Diffusers

WFOR Standard Disc Performance

Performance Graph

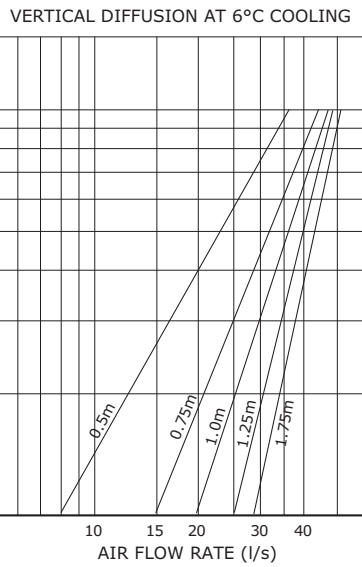
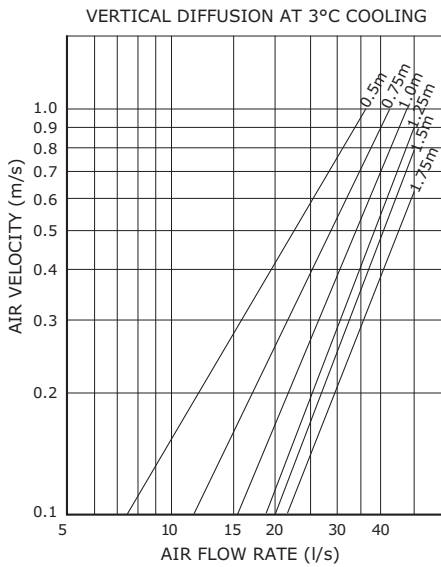

Selection Example WFOR (Horizontal Setting)
 Air Volume 25 l/s
 Jet velocity at 1m from the diffuser will be 0.26 m/s for 3°C cooling
 Pressure Drop 25Pa
 Noise Level 29 dBA

Pressure Loss Data - Both Settings

	Air Flow Rate (l/s)						
	10	15	20	25	30	35	40
Static Pressure Loss (Pa)							
WFOR	5	10	17	25	35	45	56
WFORS	5	10	17	27	38	50	-
WFORP	7	17	29	45	64	-	-
WFOR	4	7	12	19	26	35	45

All pressure loss data is based on a fully open damper

Acoustic Data - Horizontal Setting

	Air Flow Rate (l/s)						
	10	15	20	25	30	35	40
dBA L _w (Ref. 8dB Room Absorption)							
WFOR	<20	<20	24	29	34	38	41
WFORS	<20	20	26	31	35	39	-
WFORP	<20	23	30	35	40	-	-
WFOR	-	-	<20	25	29	33	37

All acoustic data is based on a fully open damper and horizontal diffusion. Reduce tabulated figures by 8dBA for vertical diffusion.

WFOV Low Pressure Disc Performance

Performance Graph

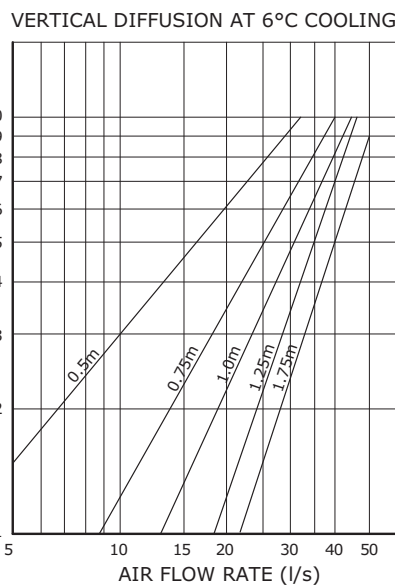
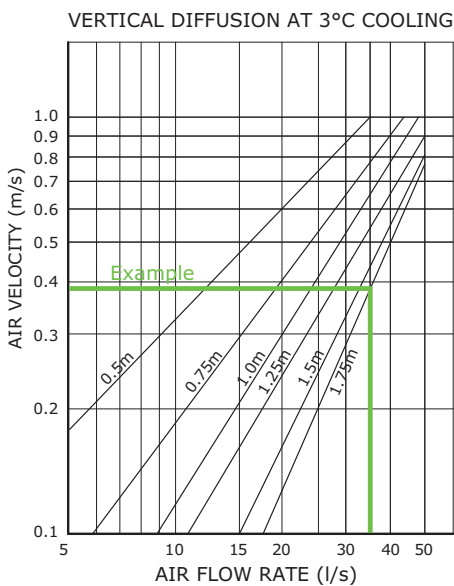

Selection Example WFOV
 Air Volume 35 l/s
 Jet velocity at 1.75m vertically from the diffuser will be 0.39 m/s for 3°C cooling
 Pressure Drop 20Pa
 Noise Level 23 dBA

Pressure Loss Data

	Air Flow Rate (l/s)						
	10	15	20	25	30	35	40
Static Pressure Loss (Pa)							
WFOVT	2	4	7	11	15	20	26
WFOVP	7	17	29	45	64	-	-

All pressure loss data is based on a fully open damper

Acoustic data

	Air Flow Rate (l/s)						
	10	15	20	25	30	35	40
dBA L _w (Ref. 8dB Room Absorption)							
WFOVT	-	-	-	-	<20	23	27
WFOVP	<20	23	30	35	40	-	-

All acoustic data is based on a fully open damper.

Aircell Polymer Floor Diffusers

WFOI High Induction Disc Performance

Performance Graph

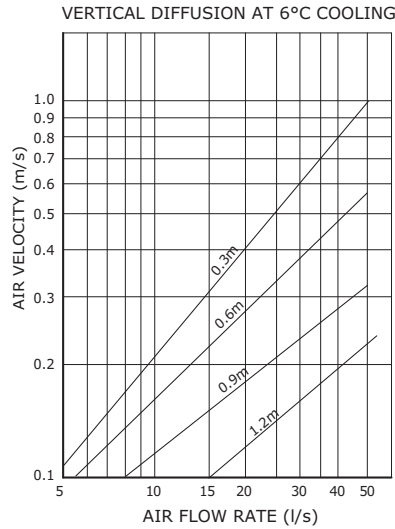
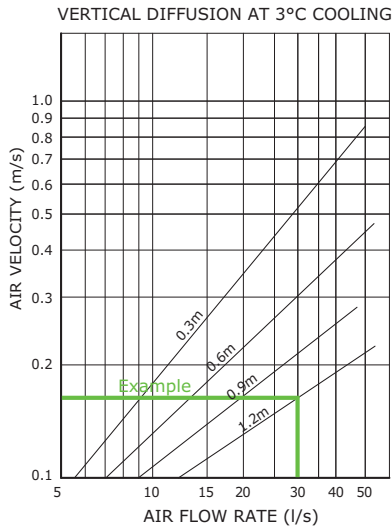

Pressure Loss Data

	Air Flow Rate (l/s)				
	20	25	30	35	40
Static Pressure Loss (Pa)					
WFOIT	4	7	10	15	22
WFOIP	6	16	26	34	42

All pressure loss data is based on a fully open damper

Acoustic data

	Air Flow Rate (l/s)				
	20	25	30	35	40
dBA L _w (Ref. 8dB Room Absorption)					
WFOIT	-	-	<20	<20	20
WFOIP	<20	<20	22	25	29

All acoustic data is based on a fully open damper.



Selection Example

WFOI

Air Volume 30 l/s
 Jet velocity at 1.2m vertically from the diffuser will be 0.17 m/s for 3°C cooling
 Pressure Drop 10Pa
 Noise Level 12 dBA

Aircell Polymer Floor Diffusers

Installation

Type WFO * T (Tile installation)

Type WFO * T Diffusers are suitable for installation into floor tiles from 23.5mm to 50mm thick. A 211mm diameter hole is drilled/cut through the tile. Ensuring the aperture is free from shavings/rough edges etc., insert the mounting frame into the hole. Locate locking collar onto the underside body of the mounting frame and tighten to the underside of the tile. The main body of the unit should now be firmly held in position, screw holes are provided in the locking collar should additional fixing be required. The combined damper/dirt tray can now be positioned into the mounting frame. Ensure that the damper airways are open and place location peg into the slot provided to lock in position. Finally select the air pattern required either vertical or horizontal by referring to the disc location tab and place into the aperture ensuring alignment tab engages with the cut out in the mounting frame. To remove the disc use the tool provided.

Type WFO * P (Tile installation with plenum)

Installation as described for WFO * T. Take the mounting collar and place it facedown on the plenum box opening. Align the fixing holes and secure using the self tapping screws supplied. Place diffuser frame in the tile opening and engage with mounting ring. Screw bracket into mounting ring until flush. Adjust spigot portion as required. Lay the tile and connect up to ductwork.

To remove the disc use the tool provided.

Type WFO * S (Slab floor or wall installation)

The steel sleeve is positioned to the customers requirements and cast into concrete floor/wall slab. Ensure that the sleeve and face flange are free from debris, fit the mounting clamps, screws and cylinder nuts as shown, to the mounting frame, insert into steel sleeve, gradually tighten the screw head clockwise until the cylinder nut has expanded the clip into the sleeve groove. Establish that the mounting frame is secure and insert damper/dirt tray locking pin, and diffuser disc.

There is no requirement for the locking collar so this can be disposed of.

To remove the disc use the tool provided.

Type WFO * D (Diffuser disc only)

Drill/cut a 211mm diameter hole in the floor, 20.5 mm deep. Ensure the aperture is free of shavings/debris and place the disc into position. To remove the disc use the tool provided.

